

hidrobox[®]

by absara



BAÑERAS



hidrobox[®]

BAÑERAS

ES.V.05.18

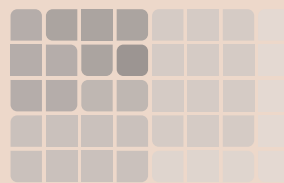

hidrobox®

BAÑERAS

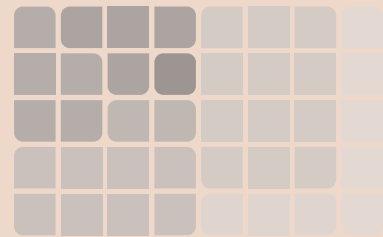

Catálogo de bañeras
Tarifados
Información técnica
ver índice

Totems y otros
elementos auxiliares a pared
pág. 46

Repuestos y Complementos
pág. 78

Materiales
pág. 79



Space

4



Beta Essential

14



Alfa Essential

32



Alfa Essential Deco

42



Beta Fusion

48



Alfa Fusion

60



Bañeras acrílicas

72

- Plane
- Urban
- Cora
- Joy
- Marina
- Intro
- Vela
- Area

el baño
BAÑERAS EXENTAS

SPACE





SPACE 180x85 blanco/ral6034, con rebosadero integrado

SPACE

el baño
BAÑERAS EXENTAS





SPACE 170x80 blanco/ral9011, con rebosadero integrado y Estante a pared para grifería de 200x20h





SPACE 180x85 blanco, con rebosadero integrado



SPACE 180x85 blanco, con rebosadero integrado y Tótem auxiliar de 60x100h con estantes



space 180x85

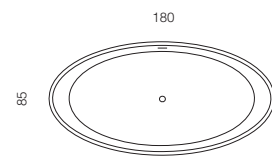

space 170x80

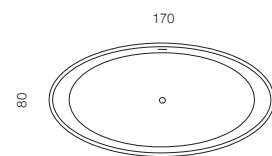

space 155x78

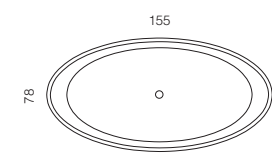

SPACE

el baño
BAÑERAS EXENTAS
información técnica

BAÑERA SPACE / SPACE BATHTUB / Baignoire SPACE / BANHEIRA SPACE

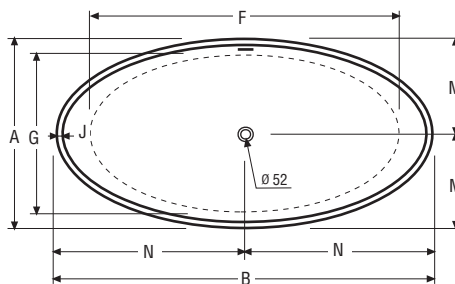
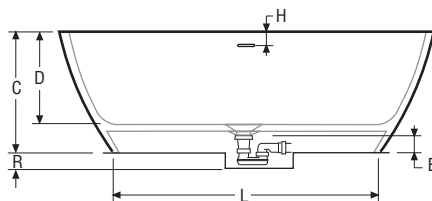
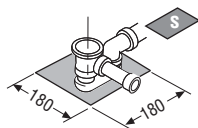
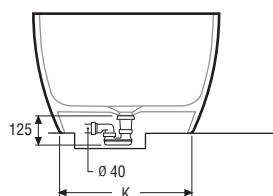

	180x85	170x80	155x78
A	850	800	780
B	1800	1700	1550
C	535	535	500
D	440	440	410
E	70	70	70
F	1500	1360	1270
G	680	670	650
H	60	60	60
J	25	25	25
K	630	580	555
L	1350	1250	1140
M	425	400	390
N	900	850	775
R	60	60	60

Medidas en mm / Sizes in mm
Mesures en mm / Medidas em mm

Desagüe presurizado / Pressurized drainage / Vidage pressurisée / Válvula presurizada

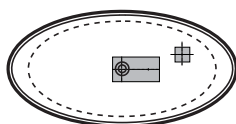
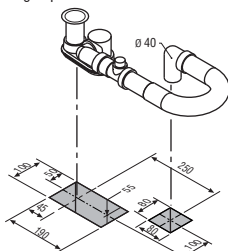

Solicite en fábrica más información sobre el funcionamiento del desagüe presurizado.

Please consult Hydrobox for further details regarding the pressurized waste valve.

Veuillez vous adresser à l'usine pour plus d'information sur le fonctionnement du vidage pressurisé.

Solicite à fábrica mais informação sobre o funcionamento da válvula pressurizada.

Blower	0,5 Kw	230 v 50 Hz	S Área desagüe. Desagüe Ø 40mm / Drain area. Ø40mm / Zone pour la vidange. Ø40mm / Area do escoamento. Ø40mm
Cromotherapy	0,05 Kw		

Modelo / Model / Modèle / Modelo	180x85	170x80	155x78
Capacidad / Capacity / Capacité / Capacidade (L)	340	300	255
Volumen de expedición sin palet / Shipping volume without pallet / Volume à l'expédition sans palet / Volume expedição sin palet (m³)	1,20	1,20	0,89
Peso de expedición / Shipping weight / Poids à l'expédition / Peso de expedição (Kg)	220	200	180

UBICACIÓN DE COMPONENTES / EMLACEMENT DES COMPOSANTS / COMPONENT LOCATION / SITUAÇÃO DE COMPONENTES

AIR SYSTEM + cromotherapy

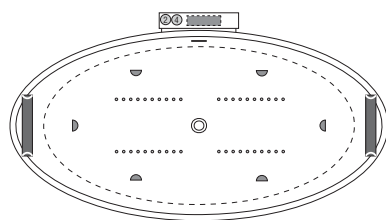

* Paneles sistema / System panel / Comande systeme / Painel Sistema.			
AIR SYSTEM	⊕	Botón marcha-para Blower / On-Off Blower Buton / Bouton marche-arret blower / Botón marcha-para Blower.	CROMOTHERAPY
	○	Inyector aire / Air injector / Injecteur air / Injetor ar.	
	■	Blower / Blower / Blower / Blower.	
	⊕	Botón marcha-para Cromotherapy / On-Off Cromotherapy Buton / Bouton marche-arret Cromotherapy / Botón marcha-para Cromotherapy.	
	▲	Foco / Spotlight / Spot lumineux / Foco.	
* Accesorios / Accessories / Accessoires / Accesorios.			
	■	Cabezal / Headrest / Appui-tête / Almofada.	

* Opcional / Optional / Optionnel / Opcional.

OPCIONES DEL PRODUCTO E INFORMACIÓN TÉCNICA IMPORTANTE

el baño
BAÑERAS EXENTAS
tarifa

SPACE

SPACE

Scene / BLANCO		
155x78	170x80	180x85

SPACE SIN REBOSADERO

Incluida válvula click-clack cromo

BSPC 0001

BSPC 0002

BSPC 0003

Válvula presurizada H2 cromo

SPACE CON REBOSADERO INTEGRADO

Incluida válvula click-clack cromo

BSPC 0004

BSPC 0005

BSPC 0006

OPCIONES DE EQUIPAMIENTO



Cromotherapy



Air System

OPCIONES DE TÓTEM Más información en página 46

El Tótem es necesario para equipamientos Air System o Cromotherapy y se dispondrá solidario a la bañera



Tótem auxiliar de 40x57h

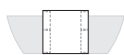

Tótem auxiliar de 60x57h con estantes

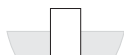

Tótem auxiliar de 40x80h



Tótem auxiliar de 60x80h con estantes

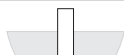

Tótem auxiliar de 21x80h



Tótem auxiliar de 60x100h con estantes

Preparación para grifería en Tótem

Color exterior en bañera

Color exterior en Tótem

Cabezal C12 grafito o blanco



OTROS ELEMENTOS AUXILIARES A PARED Más información en página 47



Repisa para grifería de 70x12h

BTOC 0007



Estante a pared para grifería de 120x20h

BTOC 0008



Estante a pared para grifería de 200x20h

BTOC 0009

el baño
BAÑERAS EXENTAS

BETA ESSENTIAL





BETA ESSENTIAL V1 170x80 blanco, con rebosadero integrado y Repisa para grifería 70x12h

BETA ESSENTIAL

el baño
BAÑERAS EXENTAS





BETA ESSENTIAL V1 170x80 blanco/ral5024, con rebosadero integrado

BETA ESSENTIAL

el baño
BAÑERAS EXENTAS



BETA ESSENTIAL V1 170x80 blanco



BETA ESSENTIAL V1 170x80 blanco

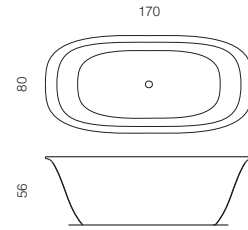

BETA ESSENTIAL V2 185x95 blanco

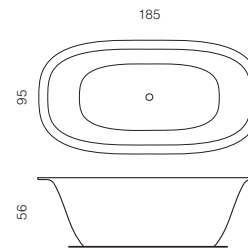

BETA ESSENTIAL V3 170x74 blanco

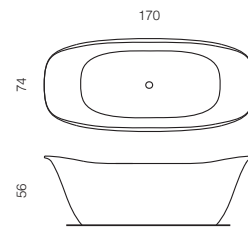

BETA ESSENTIAL V4 157x74 blanco

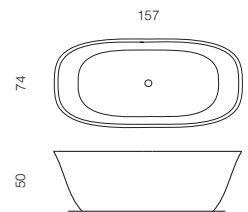

BETA ESSENTIAL

el baño
BAÑERAS EXENTAS





BETA ESSENTIAL V4 Ø140 blanco, con rebosadero integrado y Tótem auxiliar de 40x57h

BETA ESSENTIAL

el baño
BAÑERAS EXENTAS



BETA ESSENTIAL V3 150x140 blanco, con rebosadero integrado



BETA ESSENTIAL

el baño
BAÑERAS EXENTAS



BETA ESSENTIAL V5 Ø150 blanco



BETA ESSENTIAL V1 Ø150 blanco

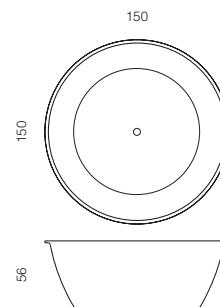

BETA ESSENTIAL V3 150x140 blanco

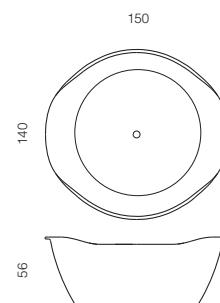

BETA ESSENTIAL V4 Ø140 blanco

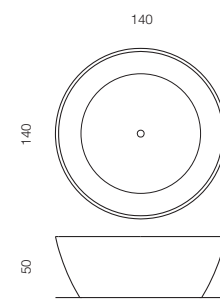

BETA ESSENTIAL V5 Ø150 blanco

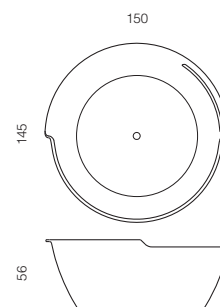

BETA ESSENTIAL

el baño
BAÑERAS EXENTAS
información técnica

BAÑERA BETA ESSENTIAL V1 170x80 / BETA ESSENTIAL V1 170x80 BATHTUB /
BAIGNOIRE BETA ESSENTIAL V1 170x80 / BANHEIRA BETA ESSENTIAL V1 170x80

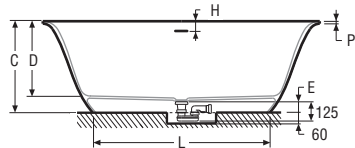
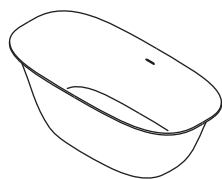

A	800	H	80
B	1700	I	95
C	560	J	55
D	470	L	1090
E	70	M	400
F	1180	N	850
G	525	P	15

Medidas en mm / Sizes in mm
Mesures en mm / Medidas em mm

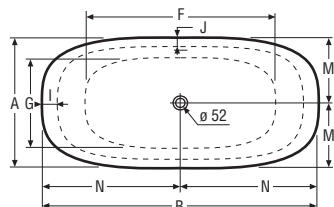

BAÑERA BETA ESSENTIAL V2 185x95 / BETA ESSENTIAL V2 185x95 BATHTUB /
BAIGNOIRE BETA ESSENTIAL V2 185x95 / BANHEIRA BETA ESSENTIAL V2 185x95

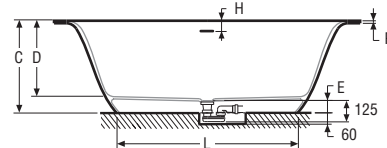
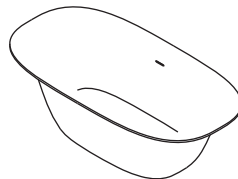

A	950	H	80
B	1850	I	75
C	560	J	75
D	470	L	1090
E	70	M	475
F	1180	N	925
G	525	P	15

Medidas en mm / Sizes in mm
Mesures en mm / Medidas em mm

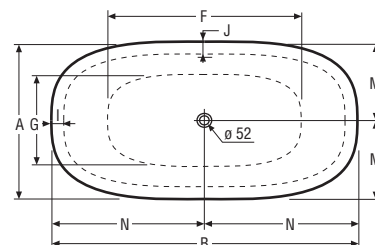

BAÑERA BETA ESSENTIAL V3 170x74 / BETA ESSENTIAL V3 170x74 BATHTUB /
BAIGNOIRE BETA ESSENTIAL V3 170x74 / BANHEIRA BETA ESSENTIAL V3 170x74

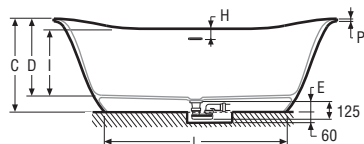
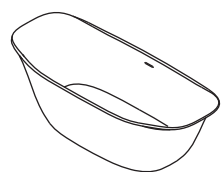

A	735	H	60
B	1700	I	410
C	560	J	25
D	470	L	1090
E	70	M	367,5
F	1180	N	850
G	525	P	15

Medidas en mm / Sizes in mm
Mesures en mm / Medidas em mm

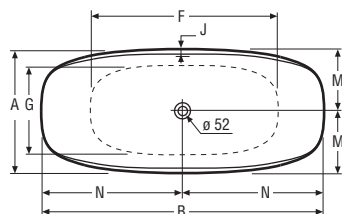

BAÑERA BETA ESSENTIAL V4 157x74 / BETA ESSENTIAL V4 157x74 BATHTUB /
BAIGNOIRE BETA ESSENTIAL V4 157x74 / BANHEIRA BETA ESSENTIAL V4 157x74

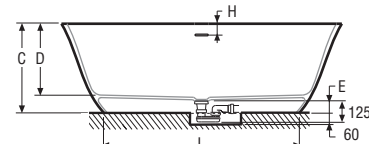
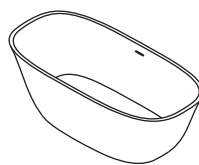

A	735	G	525
B	1570	H	60
C	500	J	25
D	410	L	1090
E	70	M	367,5
F	1180	N	785

Medidas en mm / Sizes in mm
Mesures en mm / Medidas em mm

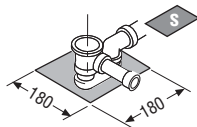
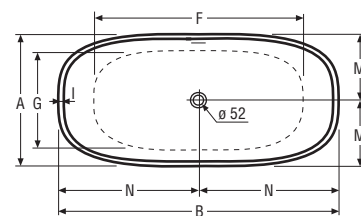

Blower	0,5 Kw	230 v 50 Hz
Cromotherapy	0,05 Kw	

S Área desagüe. Desagüe Ø 40mm / Drain area. Ø40mm / Zone pour la vidange. Ø40mm /
Área do escoamento. Ø40mm

Modelo / Model / Modèle / Modelo	V1 170x80	V2 185x95	V3 170x74	V4 157x74
Capacidad / Capacity / Capacité / Capacidade (L)	300	300	251	251
Volumen de expedición sin palet / Shipping volume without pallet / Volume à l'expédition sans palet / Volume expedição sin palet (m³)	1,17	1,67	1,17	1,17
Peso de expedición / Shipping weight / Poids à l'expédition / Peso de expedição (Kg)	165	194	158	153

DESAGÜE PRESURIZADO / PRESSURIZED DRAINAGE / VIDAGE PRESSURISÉE / VÁLVULA PRESURIZADA

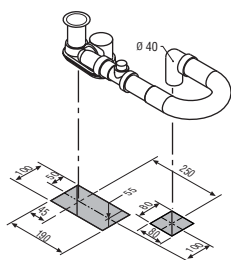
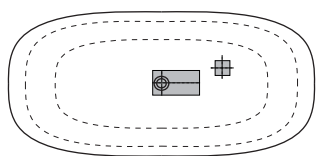

UBICACIÓN DE COMPONENTES / COMPONENT LOCATION / EMBLACEMENT DES COMPOSANTS / SITUAÇÃO DE COMPONENTES

AIR SYSTEM
+ cromotherapy

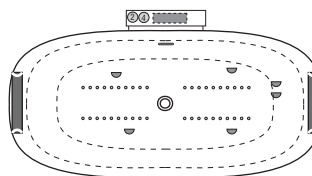

* Paneles sistema / System panel / Comande système / Painel Sistema.

AIR SYSTEM
 ● Botón marcha-para Blower / On-Off Blower Buton / Bouton marche-arret blower / Botón marcha-para Blower.
 ○ Inyector aire / Air injector / Injecteur air / Injetor ar.
 ■■■■■ Blower / Blower / Blower / Blower.

CROMOTHERAPY
 ● Botón marcha-para Cromotherapy / On-Off Cromotherapy Buton / Bouton marche-arret Cromotherapy / Botón marcha-para Cromotherapy.
 ▲ Foco / Spotlight / Spot lumineux / Foco.

* Accesorios / Accessories / Accessoires / Accesorios.

■ Cabezal / Headrest / Appui-tête / Almofada.





* Opcional / Optional / Optionnel / Opcional.

Solicite en fábrica más información sobre el funcionamiento del desagüe presurizado. / Please consult Hydrobox for further details regarding the pressurized waste valve. / Veuillez vous adresser à l'usine pour plus d'information sur le fonctionnement du vidage pressurisé. / Solicite à fábrica mais informação sobre o funcionamento da válvula pressurizada.

OPCIONES DEL PRODUCTO E INFORMACIÓN TÉCNICA IMPORTANTE

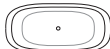
el baño
BAÑERAS EXENTAS
tarifa

BETA ESSENTIAL

Scene / BLANCO			
V1 170x80	V2 185x95	V3 170x74	V4 157x74
			

BETA ESSENTIAL SIN REBOSADERO

BBEC 0001 BBEC 0002 BBEC 0003 BBEC 0004

Incluida válvula click-clack cromo

↳ Válvula presurizada H1 cromo

BETA ESSENTIAL CON REBOSADERO INTEGRADO

BBEC 0005 BBEC 0006 BBEC 0007 BBEC 0008

Incluida válvula click-clack cromo

OPCIONES DE EQUIPAMIENTO



Cromotherapy



Air System

OPCIONES DE TÓTEM Más información en página 46

El Tótem es necesario para equipamientos Air System o Cromotherapy y se dispondrá solidario a la bañera



Tótem auxiliar de 40x57h



Tótem auxiliar de 60x57h con estantes

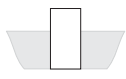

Tótem auxiliar de 40x80h



Tótem auxiliar de 60x80h con estantes

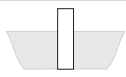

Tótem auxiliar de 21x80h

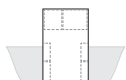

Tótem auxiliar de 60x100h con estantes

↳ Preparación para grifería en Tótem

↳ Color exterior en bañera

↳ Color exterior en Tótem

↳ Cabezal C12 grafito o blanco



OTROS ELEMENTOS AUXILIARES A PARED Más información en página 47



Repisa para grifería de 70x12h

BTOC 0007



Estante a pared para grifería de 120x20h

BTOC 0008



Estante a pared para grifería de 200x20h

BTOC 0009

BETA ESSENTIAL

el baño
BAÑERAS EXENTAS
información técnica

BAÑERA BETA ESSENTIAL V1 Ø140 / BETA ESSENTIAL V1 Ø140 BATHTUB /
BAIGNOIRE BETA ESSENTIAL V1 Ø140 / BANHEIRA BETA ESSENTIAL V1 Ø140

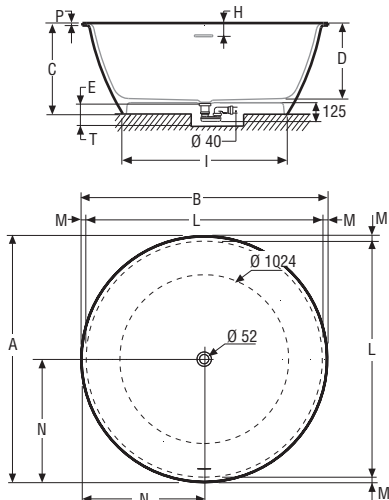
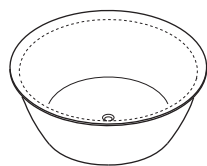

A	1400	I	1000
B	1400	L	1310
C	560	M	27
D	470	N	700
E	70	P	15
H	80	T	60

Medidas en mm / Sizes in mm
Mesures en mm / Medidas em mm

BAÑERA BETA ESSENTIAL V3 140x127 / BETA ESSENTIAL V3 140x127 BATHTUB /
BAIGNOIRE BETA ESSENTIAL V3 140x127 / BANHEIRA BETA ESSENTIAL V3 140x127

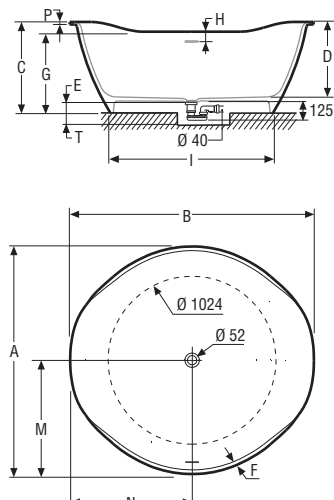
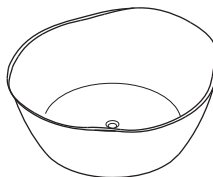

A	1270	H	60
B	1400	I	1000
C	560	M	635
D	470	N	700
E	70	P	15
F	25	T	60
G	500		

Medidas en mm / Sizes in mm
Mesures en mm / Medidas em mm

BAÑERA BETA ESSENTIAL V4 Ø127 / BETA ESSENTIAL V4 Ø127 BATHTUB /
BAIGNOIRE BETA ESSENTIAL V4 Ø127 / BANHEIRA BETA ESSENTIAL V4 Ø127

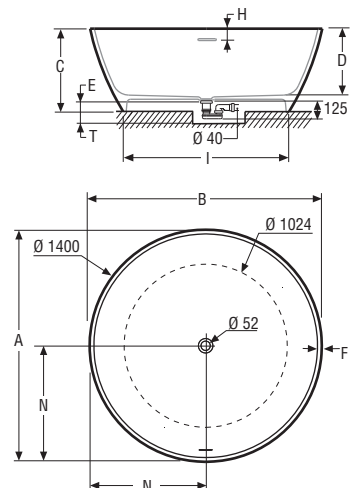
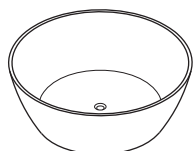

A	1270	H	60
B	1270	I	1000
C	500	N	635
D	410	T	60
E	70		
F	25		

Medidas en mm / Sizes in mm
Mesures en mm / Medidas em mm

BAÑERA BETA ESSENTIAL V5 Ø140 / BETA ESSENTIAL V5 Ø140 BATHTUB /
BAIGNOIRE BETA ESSENTIAL V5 Ø140 / BANHEIRA BETA ESSENTIAL V5 Ø140

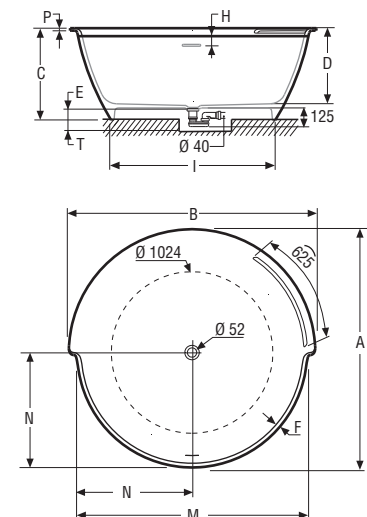
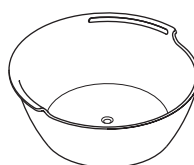

A	1350	H	60
B	1400	I	1000
C	560	M	1275
D	470	N	640
E	70	P	15
F	25	T	60

Medidas en mm / Sizes in mm
Mesures en mm / Medidas em mm

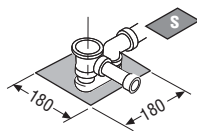

Blower	0,5 Kw	230 v 50 Hz
Cromotherapy	0,05 Kw	

S Área desagüe. Desagüe Ø 40mm / Drain area. Ø40mm / Zone pour la vidange. Ø40mm /
Área do escoamento. Ø40mm

Modelo / Model / Modèle / Modelo	V1 Ø140	V3 140x127	V4 Ø127	V5 Ø140
Capacidad / Capacity / Capacité / Capacidade (L)	370	350	350	350
Volumen de expedición sin palet / Shipping volume without pallet / Volume à l'expédition sans palet / Volume expedição sin palet (m³)	1,76	1,76	1,76	1,76
Peso de expedición / Shipping weight / Poids à l'expédition / Peso de expedição (Kg)	238	230	223	229

DESAGÜE PRESURIZADO / PRESSURIZED DRAINAGE / VIDAGE PRESSURISÉE / VÁLVULA PRESURIZADA

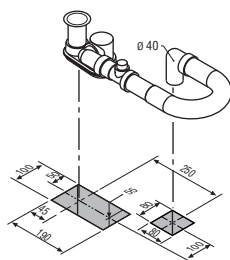
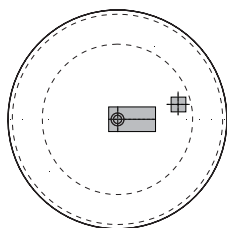

Solicite en fábrica más información sobre el funcionamiento del desagüe presurizado. / Please consult Hidrobox for further details regarding the pressurized waste valve. / Veuillez vous adresser à l'usine pour plus d'information sur le fonctionnement du vidage pressurisé. / Solicite à fábrica mais informação sobre o funcionamento da válvula pressurizada.

UBICACIÓN DE COMPONENTES / COMPONENT LOCATION / EMBLACEMENT DES COMPOSANTS / SITUAÇÃO DE COMPONENTES

AIR SYSTEM
+ cromotherapy

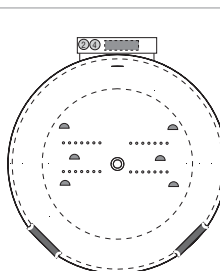





* Paneles sistema / System panel / Comande systeme / Painel Sistema.

- AIR SYSTEM**
 - ② Botón marcha-para Blower / On-Off Blower Buton / Bouton marche-arrêt blower / Botón marcha-para Blower.
 - Injector aire / Air injector / Injecteur air / Injetor ar.
 - Blower / Blower / Blower / Blower.
- CROMOTHERAPY**
 - ④ Botón marcha-para Cromotherapy / On-Off Cromotherapy Buton / Bouton marche-arrêt Cromotherapy / Botón marcha-para Cromotherapy.
 - Foco / Spotlight / Spot lumineux / Foco.

* Accesorios / Accessories / Accessoires / Accesorios.

- Cabezal / Headrest / Appui-tête / Almofada.

* Opcional / Optional / Optionnel / Opcional.

Scene / BLANCO			
V1 Ø140	V3 140x127	V4 Ø127	V5 Ø140
			
BBEC 0009	BBEC 0010	BBEC 0011	BBEC 0012

BETA ESSENTIAL SIN REBOSADERO

Incluida válvula click-clack cromo

↳ Válvula presurizada H1 cromo

BETA ESSENTIAL CON REBOSADERO INTEGRADO

Incluida válvula click-clack cromo

OPCIONES DE EQUIPAMIENTO



Cromotherapy



Air System

OPCIONES DE TÓTEM Más información en página 46

El Tótem es necesario para equipamientos Air System o Cromotherapy y se dispondrá solidario a la bañera



Tótem auxiliar de 40x57h



Tótem auxiliar de 60x57h con estantes

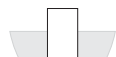

Tótem auxiliar de 40x80h



Tótem auxiliar de 60x80h con estantes

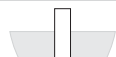

Tótem auxiliar de 21x80h

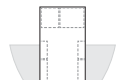

Tótem auxiliar de 60x100h con estantes

Preparación para grifería en Tótem

Color exterior en bañera

Color exterior en Tótem

Cabezal C12 grafito o blanco



OTROS ELEMENTOS AUXILIARES A PARED Más información en página 47

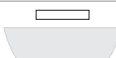

Repisa para grifería de 70x12h

BTOC 0007



Estante a pared para grifería de 120x20h

BTOC 0008



Estante a pared para grifería de 200x20h

BTOC 0009

BETA ESSENTIAL

el baño
BAÑERAS EXENTAS
información técnica

BAÑERA BETA ESSENTIAL V1 Ø150 / BETA ESSENTIAL V1 Ø150 BATHTUB /
BAIGNOIRE BETA ESSENTIAL V1 Ø150 / BANHEIRA BETA ESSENTIAL V1 Ø150

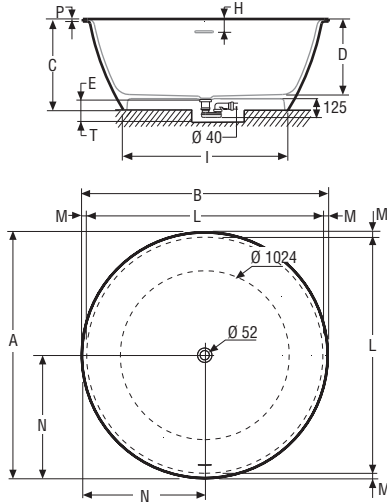
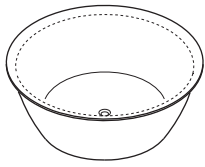

A	1500	I	1000
B	1500	L	1445
C	560	M	27
D	470	N	750
E	70	P	15
H	80	T	60

Medidas en mm / Sizes in mm
Mesures en mm / Medidas em mm

BAÑERA BETA ESSENTIAL V3 150x140 / BETA ESSENTIAL V3 150x140 BATHTUB /
BAIGNOIRE BETA ESSENTIAL V3 150x140 / BANHEIRA BETA ESSENTIAL V3 150x140

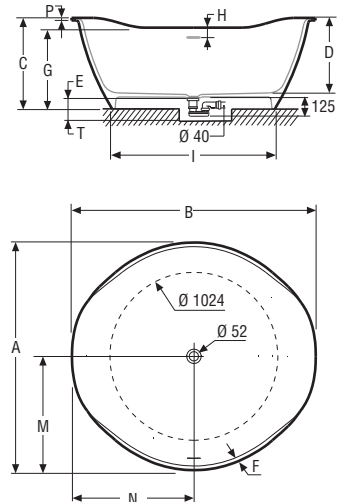
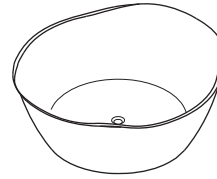

A	1400	H	60
B	1500	I	1000
C	560	M	700
D	470	N	750
E	70	P	15
F	25	T	60
G	500		

Medidas en mm / Sizes in mm
Mesures en mm / Medidas em mm

BAÑERA BETA ESSENTIAL V4 Ø140 / BETA ESSENTIAL V4 Ø140 BATHTUB /
BAIGNOIRE BETA ESSENTIAL V4 Ø140 / BANHEIRA BETA ESSENTIAL V4 Ø140

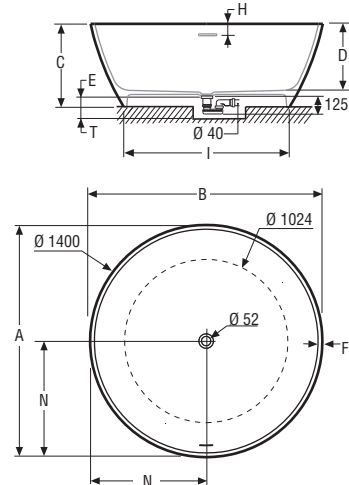
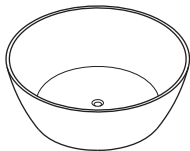

A	1400	H	60
B	1400	I	1000
C	500	N	700
D	410	T	60
E	70		
F	25		

Medidas en mm / Sizes in mm
Mesures en mm / Medidas em mm

BAÑERA BETA ESSENTIAL V5 Ø150 / BETA ESSENTIAL V5 Ø150 BATHTUB /
BAIGNOIRE BETA ESSENTIAL V5 Ø150 / BANHEIRA BETA ESSENTIAL V5 Ø150

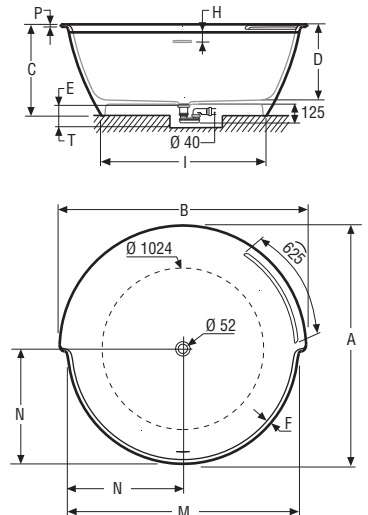
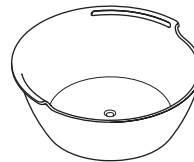

A	1450	H	60
B	1500	I	1000
C	560	M	1400
D	470	N	700
E	70	P	15
F	25	T	60

Medidas en mm / Sizes in mm
Mesures en mm / Medidas em mm

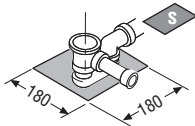

Blower	0,5 Kw	230 v 50 Hz
Cromotherapy	0,05 Kw	

Área desagüe. Desagüe Ø 40mm / Drain area. Ø40mm / Zone pour la vidange. Ø40mm /
Área do escoamento. Ø40mm

Modelo / Model / Modèle / Modelo	V1 Ø150	V3 150x140	V4 Ø140	V5 Ø150
Capacidad / Capacity / Capacité / Capacidade (L)	440	384	384	384
Volumen de expedición sin palet / Shipping volume without pallet / Volume à l'expédition sans palet / Volume expedição sin palet (m³)	1,77	1,77	1,77	1,77
Peso de expedición / Shipping weight / Poids à l'expédition / Peso de expedição (Kg)	240	232	225	231

DESAGÜE PRESURIZADO / PRESSURIZED DRAINAGE / VIDAGE PRESSURISÉE / VÁLVULA PRESURIZADA

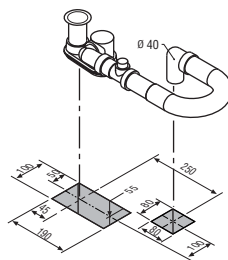
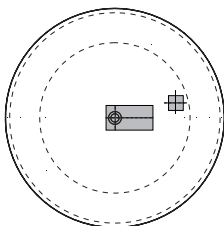

Solicite en fábrica más información sobre el funcionamiento del desagüe presurizado. / Please consult Hydrobox for further details regarding the pressurized waste valve. / Veuillez vous adresser à l'usine pour plus d'information sur le fonctionnement du vidage pressurisé. / Solicite à fábrica mais informação sobre o funcionamento da válvula presurizada.

UBICACIÓN DE COMPONENTES / COMPONENT LOCATION / EMLACEMENT DES COMPOSANTS / SITUAÇÃO DE COMPONENTES

AIR SYSTEM
+ cromotherapy

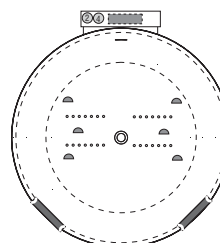

* Paneles sistema / System panel / Comande système / Painel Sistema.





AIR SYSTEM
● Botón marcha-para Blower / On-Off Blower Buton / Bouton marche-arret blower / Botón marcha-para Blower.
○ Inyectar aire / Air injector / Injecteur air / Injetor ar.
Blower / Blower / Blower / Blower.

CROMOTHERAPY
● Botón marcha-para Cromotherapy / On-Off Cromotherapy Buton / Bouton marche-arret Cromotherapy / Botón marcha-para Cromotherapy.
▲ Foco / Spotlight / Spot lumineux / Foco.

* Accesorios / Accessories / Accessoires / Accesorios.

■ Cabezal / Headrest / Appui-tête / Almofada.

* Opcional / Optional / Optionnel / Opcional.

Scene / BLANCO			
V1 Ø150	V3 150x140	V4 Ø140	V5 Ø150
			
BBEC 0017	BBEC 0018	BBEC 0019	BBEC 0020

BETA ESSENTIAL SIN REBOSADERO

Incluida válvula click-clack cromo

↳ Válvula presurizada H1 cromo

BETA ESSENTIAL CON REBOSADERO INTEGRADO

Incluida válvula click-clack cromo

OPCIONES DE EQUIPAMIENTO



Cromotherapy



Air System

OPCIONES DE TÓTEM Más información en página 46

El Tótem es necesario para equipamientos Air System o Cromotherapy y se dispondrá solidario a la bañera



Tótem auxiliar de 40x57h



Tótem auxiliar de 60x57h con estantes

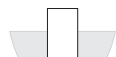

Tótem auxiliar de 40x80h



Tótem auxiliar de 60x80h con estantes



Tótem auxiliar de 21x80h

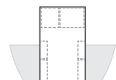

Tótem auxiliar de 60x100h con estantes

↳ Preparación para grifería en Tótem

↳ Color exterior en bañera

↳ Color exterior en Tótem

↳ Cabezal C12 grafito o blanco



OTROS ELEMENTOS AUXILIARES A PARED Más información en página 47

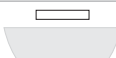

Repisa para grifería de 70x12h

BTOC 0007



Estante a pared para grifería de 120x20h

BTOC 0008



Estante a pared para grifería de 200x20h

BTOC 0009

el baño
BAÑERAS EXENTAS

ALFA ESSENTIAL





ALFA ESSENTIAL

el baño
BAÑERAS EXENTAS



ALFA ESSENTIAL 164x65 blanco/gris



alfa essential 164x65

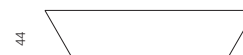
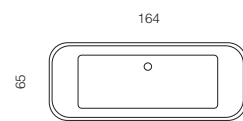

ALFA ESSENTIAL

el baño
BAÑERAS EXENTAS





ALFA ESSENTIAL 142x142 blanco/cappuccino, con rebosadero integrado y Tótem auxiliar de 60x100h con estantes

ALFA ESSENTIAL

el baño
BAÑERAS EXENTAS



ALFA ESSENTIAL 142x142 blanco/cappuccino, sin rebosadero



alfa essential 142x142

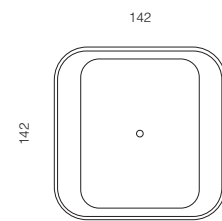

ALFA ESSENTIAL

el baño
BAÑERAS EXENTAS
información técnica

BAÑERA ALFA ESSENTIAL 164x65 / ALFA ESSENTIAL 164x65 BATHTUB / BAIGNOIRE ALFA ESSENTIAL 164x65 / BANHEIRA ALFA ESSENTIAL 164x65

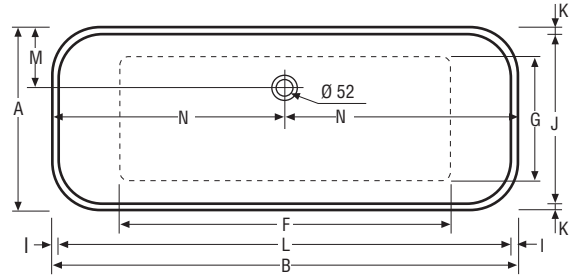
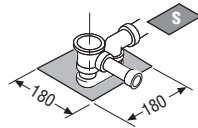
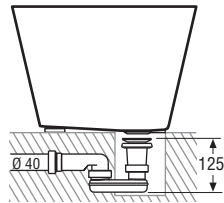
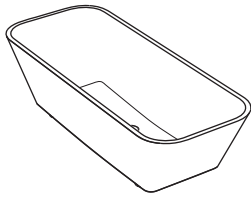

A	645
B	1635
C	440
F	1160
G	430
H	434
I	27
J	595
K	25
L	1580
M	214
N	817,5

Medidas en mm / Sizes in mm
Mesures en mm / Medidas em mm.

BAÑERA ALFA ESSENTIAL 142x142 / ALFA ESSENTIAL 142x142 BATHTUB / BAIGNOIRE ALFA ESSENTIAL 142x142 / BANHEIRA ALFA ESSENTIAL 142x142

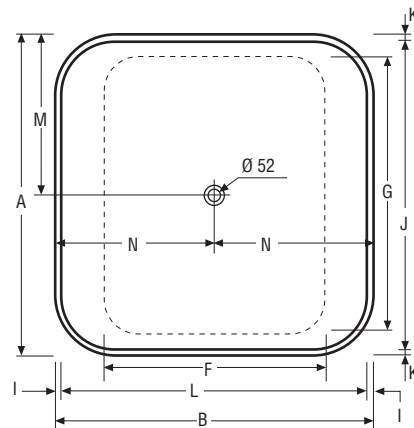
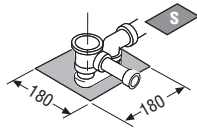
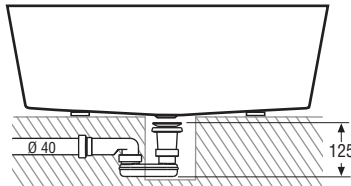
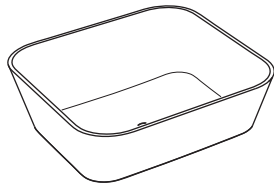

A	1420
B	1415
C	480
F	965
G	1225
H	473
I	27
J	1368
K	26
L	1360
M	710
N	707,5

Medidas en mm / Sizes in mm
Mesures en mm / Medidas em mm.

S Área desagüe. Desagüe Ø 40mm / Drain area. Ø40mm / Zone pour la vidange. Ø40mm / Area do escoamento. Ø40mm

Modelo / Model / Modèle / Modelo	164x65	142x142
Capacidad / Capacity / Capacité / Capacidade (L)	244	590
Volumen de expedición sin palet / Shipping volume without pallet / Volume à l'expédition sans palet / Volume expedição sin palet (m³)	1,06	1,82
Peso de expedición / Shipping weight / Poids à l'expédition / Peso de expedição (Kg)	145	212

Desagüe presurizado / Pressurized drainage / Vidage pressurisée / Válvula presurizada ALFA 164x65

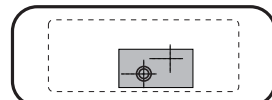
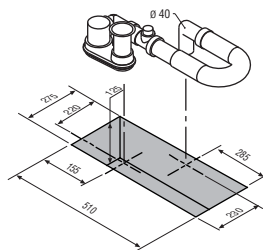

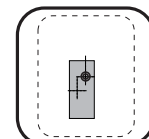
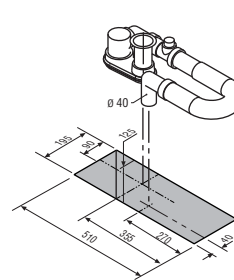

Solicite en fábrica más información sobre el funcionamiento del desagüe presurizado.
Please consult Hidrobox for further details regarding the pressurized waste valve.
Veuillez vous adresser à l'usine pour plus d'information sur le fonctionnement du vidage pressurisé.
Solicite à fábrica mais informação sobre o funcionamento da válvula pressurizada.

Desagüe presurizado / Pressurized drainage / Vidage pressurisée / Válvula presurizada ALFA 142x142

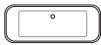

Solicite en fábrica más información sobre el funcionamiento del desagüe presurizado.
Please consult Hidrobox for further details regarding the pressurized waste valve.
Veuillez vous adresser à l'usine pour plus d'information sur le fonctionnement du vidage pressurisé.
Solicite à fábrica mais informação sobre o funcionamento da válvula pressurizada.

Scene / BLANCO	
164x65	142x142
	

ALFA ESSENTIAL SIN REBOSADERO

Incluida válvula click-clack cromo

BALC 0001

BALC 0002

↳ Válvula presurizada H1 cromo

-

Válvula presurizada H2 cromo

-

ALFA ESSENTIAL CON REBOSADERO INTEGRADO Y TÓTEM

Incluida válvula click-clack cromo

BALC 0003

BALC 0004

↳ OPCIONES DE TÓTEM Más información en página 46

El Tótem es necesario para disponer rebosadero integrado y se dispondrá solidario a la bañera



Tótem auxiliar de 40x57h



Tótem auxiliar de 60x57h con estantes



Tótem auxiliar de 40x80h



Tótem auxiliar de 60x80h con estantes



Tótem auxiliar de 21x80h



Tótem auxiliar de 60x100h con estantes

↳ Preparación para grifería en Tótem

↳ Color exterior en bañera

↳ Color exterior en Tótem

↳ Cabezal C11 grafito o blanco



OTROS ELEMENTOS AUXILIARES A PARED Más información en página 47



Repisa para grifería de 70x12h

BTOC 0007



Estante a pared para grifería de 120x20h

BTOC 0008



Estante a pared para grifería de 200x20h

BTOC 0009

| el baño
| BAÑERAS EXENTAS

ALFA ESSENTIAL

DECO



ALFA ESSENTIAL DECO 175x75 blanco, con pies blancos



ALFA ESSENTIAL

DECO

el baño
BAÑERAS EXENTAS
información técnica

BAÑERA ALFA ESSENTIAL DECO / ALFA ESSENTIAL DECO BATHTUB / BAIGNOIRE ALFA ESSENTIAL DECO / BANHEIRA ALFA ESSENTIAL DECO

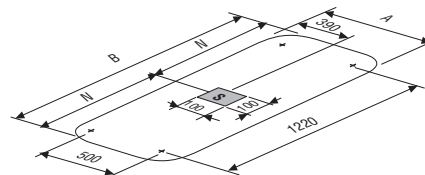
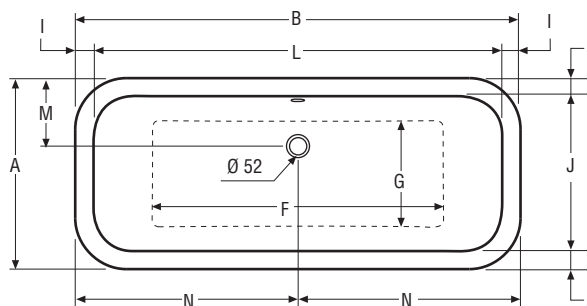
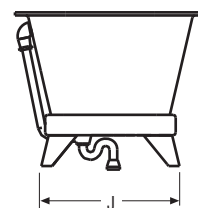
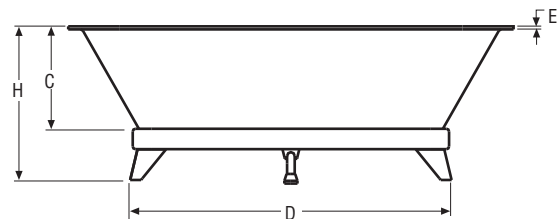
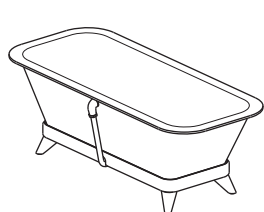

A	750
B	1750
C	400
D	1260
E	12
F	1160
G	430
H	600
I	75
J	545
M	270
N	875

Medidas en mm /
Sizes in mm /
Mesures en mm /
Medidas em mm.

S Área desagüe. Desagüe Ø 40mm / Drain area. Ø40mm / Zone pour la vidange. Ø40mm / Area do escoamento. Ø40mm	
Modelo / Model / Modèle / Modelo	175x75
Capacidad / Capacity / Capacité / Capacidade (L)	230
Volumen de expedición sin palet / Shipping volume without pallet / Volume à l'expédition sans palet / Volume expedição sin palet (m³)	1,67
Peso de expedición / Shipping weight / Poids à l'expédition / Peso de expedição (Kg)	-

OPCIONES DEL PRODUCTO
E INFORMACIÓN TÉCNICA IMPORTANTE

el baño
BAÑERAS EXENTAS
tarifa

ALFA ESSENTIAL

DECO

Scene / BLANCO

175x75



ALFA ESSENTIAL DECO + Pies Deco (blancos)

BALC 0005

Desagüe cromado visto incluido en el precio

ALFA ESSENTIAL DECO + Pies Deco (negros)

BALC 0006

Desagüe cromado visto incluido en el precio

↳ Color exterior en bañera

↳ Cabezal C11 grafito o blanco



TÓTEM

el baño
COMPLEMENTOS BAÑERAS
tarifa / información técnica

TÓTEM AUXILIAR EXENTO PARA BAÑERAS

El Tótem se dispondrá separado de la bañera



Tótem auxiliar de 40x57h

BTOC 0001



Tótem auxiliar de 60x57h con estantes

BTOC 0002



Tótem auxiliar de 40x80h

BTOC 0003



Tótem auxiliar de 60x80h con estantes

BTOC 0004



Tótem auxiliar de 21x80h

BTOC 0005



Tótem auxiliar de 60x100h con estantes

BTOC 0006

↳ Color exterior en Tótem

↳ Consultar formatos especiales

↳ Preparación para grifería en Tótem

OTROS ELEMENTOS AUXILIARES A PARED

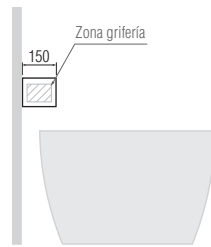
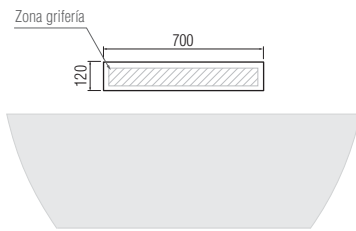

Repisa para grifería de 70x12h

BTOC 0007

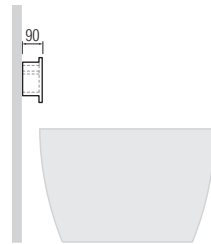
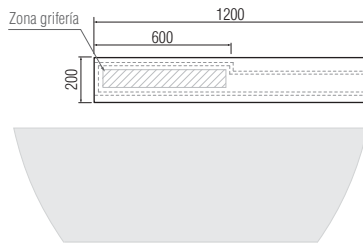

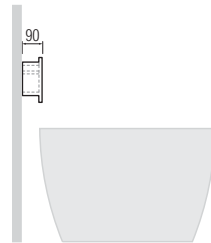
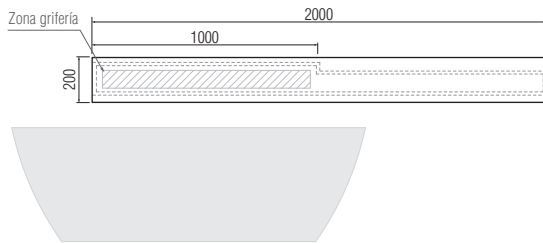

Estante a pared para grifería de 120x20h

BTOC 0008



Estante a pared para grifería de 200x20h

BTOC 0009

-  Color exterior en elemento auxiliar a pared
-  Preparación para grifería en elemento auxiliar a pared

-  Consultar formatos especiales

el baño
BAÑERAS DE ENCASTRE

BETA FUSION



BETA FUSION

BETA FUSION 190x90 blanco

BETA FUSION

el baño
BAÑERAS DE ENCASTRE



BETA FUSION 200x100 blanco

beta fusion (175-200)x(85-100)



beta fusion 185x100



beta fusion free design



free design area

free design examples



BETA FUSION

el baño
BAÑERAS DE ENCASTRE





BETA FUSION 150x150 blanco

BETA FUSION

el baño
BAÑERAS DE ENCASTRE



BETA FUSION 150x150 blanco

beta fusion 140x140



beta fusion 150x150



beta fusion Ø150



beta fusion free design

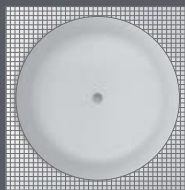

free design area

free design examples



BETA FUSION

el baño
BAÑERAS DE ENCASTRE
información técnica

BAÑERA BETA FUSION / BETA FUSION BATHTUB / Baignoire BETA FUSION / BANHEIRA BETA FUSION

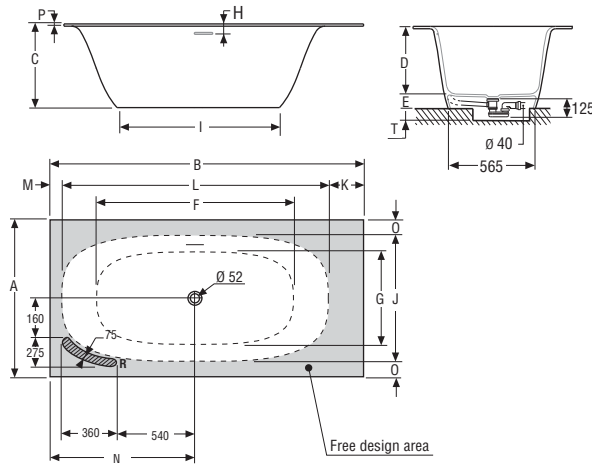
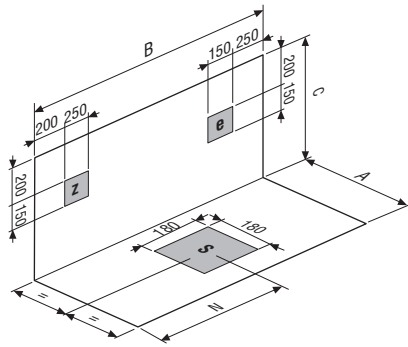

	(175-200)x(95-100)	100x185	Free design
A	850 → 1000	1000	800 → 1000
B	1750 → 2000	1850	1700 → 2000
C	560	560	560
D	470	470	470
E	70	70	70
F	1180	1180	1180
G	525	525	525
H	80	80	80
I	1090	1090	1090
J	800	800	800
K	25 → 225	75	0 → 225
L	1700	1700	1700
M	25 → 75	75	0 → 75
N	875 → 925	925	850 → 925
O	25 → 100	75	0 → 100
P	15	15	15
T	60	60	60

Medidas en mm / Sizes in mm / Mesures en mm / Medidas em mm.

Blower	0,5 Kw	230 v 50 Hz
Cromotherapy	0,05 Kw	

S Área desagüe. Desagüe Ø 40mm / Drain area. Ø40mm / Zone pour la vidange. Ø40mm / Area do escoamento.

e Área conexión eléctrica / Electrical connection area / Zone pour le raccordement électrique / Area do ligação eléctrica.

R Zona sugerida para Grifería en borde bañera. UNE 232. En los formatos inferiores a 185x90 cm no se puede incorporar grifería. / Zone suggested for faucetry fittings on the bathtub, UNE 232. Faucetry can not be fitted to formats measuring less than 185x90cm. / Zone suggérée pour Robinetterie sur le bord de la baignoire, UNE 232. Sur les formats inférieurs à 185x90cm il ne peut pas s'incorporer de robinetterie. / Zona sugerido a Torneira en Banheira, UNE 232. Nos formatos inferiores a 185x90 cm não se pode incorporar torneira.

Z Conexiones para Grifería en borde bañera / Connection for the bathtub featured with faucetry / Raccordement pour Robinetterie sur le bord de la baignoire / Ligação a Torneira en Banheira.

Modelo / Model / Modèle / Modelo	200x100
Capacidad / Capacity / Capacité / Capacidade (L)	300
Volumen de expedición sin palet / Shipping volume without pallet / Volume à l'expédition sans palet / Volume expedição sin palet (m³)	1,67
Peso de expedición / Shipping weight / Poids à l'expédition / Peso de expedição (Kg)	222

UBICACIÓN DE COMPONENTES / EMBLACEMENT DES COMPOSANTS / COMPONENT LOCATION / SITUAÇÃO DE COMPONENTES

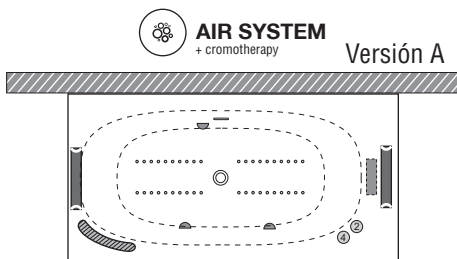

* Paneles sistema / System panel / Comande sistema / Painel Sistema.	
CRAMOTERAPIA	<ul style="list-style-type: none"> ⓐ Botón marcha-para Cromotherapy / On-Off Cromotherapy Buton / Bouton marche-arret Cromotherapy / Botón marcha-para Cromotherapy. ☛ Foco / Spotlight / Spot lumineux / Foco.
AIR SYSTEM	<ul style="list-style-type: none"> ⓑ Botón marcha-para Blower / On-Off Blower Buton / Bouton marche-arret blower / Botón marcha-para Blower. ○ Inyector aire / Air injector / Injeteur air / Injetor ar. ▬ Blower / Blower / Blower / Blower.
* Grifería / Faucetry / Robinetterie / Torneira.	
<p>▨ Zona sugerida para Grifería / Zone suggested for faucetry fittings / Zone suggérée pour Robinetterie / Zona sugerido a Torneira en Banheira.</p>	
* Accesorios / Accessories / Accessoires / Accesorios.	
<p>▬ Cabezal / Headrest / Appui-têtes / Almofada.</p>	

* Opcional / Optional / Optionnel / Opcional.

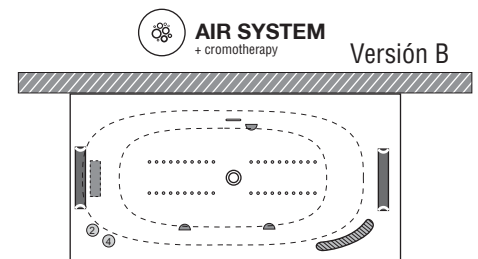

OPCIONES DEL PRODUCTO
E INFORMACIÓN TÉCNICA IMPORTANTE

el baño
BAÑERAS DE ENCASTRE
tarifa

BETA FUSION

Scene / BLANCO		
(175-200)x(85-100)	100x185	FREE DESIGN
		 según diseño cliente
BBEC 0025	BBEC 0026	BBEC 0027

BETA FUSION SIN HIDROMASAJE (con rebosadero integrado)

Incluido desagüe click-clack cromo

OPCIONES DE EQUIPAMIENTO

Los pedidos sin especificación de versión se suministrarán en versión A



Cromotherapy



Air System

Preparación para grifería

Cabezal C12 grafito o blanco



BETA FUSION

el baño
BAÑERAS DE ENCASTRE
información técnica

BAÑERA BETA FUSION / BETA FUSION BATHTUB / BAIGNOIRE BETA FUSION / BANHEIRA BETA FUSION

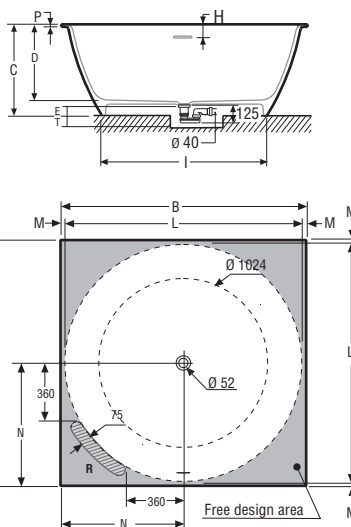
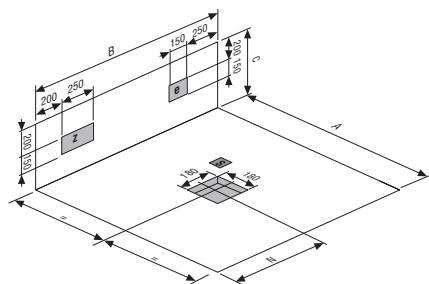

	140x140	150x150	Ø150	Free design
A	1400	1500	1500	1500
B	1400	1500	1500	1500
C	560	560	560	560
D	470	470	470	470
E	70	70	70	70
H	80	80	80	80
I	1000	1000	1000	1000
L	1310	1445	1445	1445
M	45	27	27	27
N	700	750	750	750
P	15	15	15	15
T	60	60	60	60

Medidas en mm / Sizes in mm /
Mesures en mm / Medidas em mm.

Blower	0,5 Kw	230 v 50 Hz
Cromotherapy	0,05 Kw	

s Área desagüe. Desagüe Ø 40mm / Drain area. Ø40mm / Zone pour la vidange. Ø40mm / Area do escoamento.

e Área conexión eléctrica / Electrical connection area / Zone pour le raccordement électrique / Area do ligação eléctrica.

R	Zona sugerida para Grifería en borde bañera, UNE 232 / Zone suggested for faucetry fittings on the bathtub, UNE 232 / Zone suggérée pour Robinetterie sur le bord de la baignoire, UNE 232 / Zona sugerido a Torneira en Banheira	Z	Conexiones para Grifería en borde bañera / Connection for the bathtub featured with faucetry / Raccordement pour Robinetterie sur le bord de la baignoire / Ligação a Torneira en Banheira.
----------	---	----------	---

Modelo / Model / Modèle / Modelo	140x140	150x150
Capacidad / Capacity / Capacité / Capacidade (L)	370	440
Volumen de expedición sin palet / Shipping volume without pallet / Volume à l'expédition sans palet / Volume expedição sin palet (m³)	1,77	1,77
Peso de expedición / Shipping weight / Poids à l'expédition / Peso de expedição (Kg)	250	252

UBICACIÓN DE COMPONENTES / EMPLACEMENT DES COMPOSANTS / COMPONENT LOCATION / SITUAÇÃO DE COMPONENTES

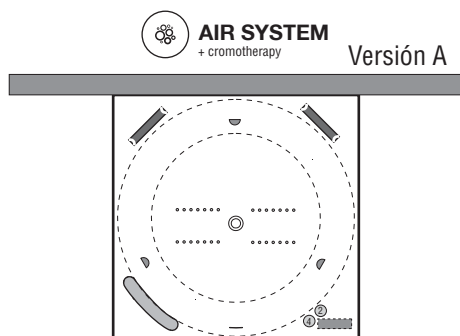

* Paneles sistema / System panel / Comande systeme / Painel Sistema.	
CROMOTHERAPY	<p>① Botón marcha-para Cromotherapy / On-Off Cromotherapy Buton / Bouton marche-arret Cromotherapy / Botón marcha-para Cromotherapy.</p> <p>☛ Foco / Spotlight / Spot lumineux / Foco.</p>
AIR SYSTEM	<p>② Botón marcha-para Blower / On-Off Blower Buton / Bouton marche-arret blower / Botón marcha-para Blower.</p> <p>○ Inyector aire / Air injector / Injecteur air / Injetor ar.</p> <p>▬ Blower / Blower / Blower / Blower.</p>
* Grifería / Faucetry / Robinetterie / Torneira.	
▨ Zona sugerida para Grifería / Zone suggested for faucetry fittings / Zone suggérée pour Robinetterie / Zona sugerido a Torneira en Banheira.	
* Accesorios / Accessories / Accessoires / Accesorios.	
▬ Cabezal / Headrest / Appui-têtes / Almofada.	



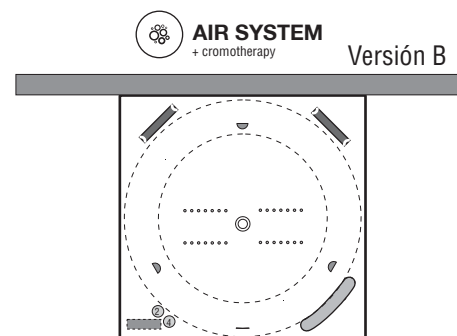

* Opcional / Optional / Optionnel / Opcional.



OPCIONES DEL PRODUCTO
E INFORMACIÓN TÉCNICA IMPORTANTE

el baño
BAÑERAS DE ENCASTRE
tarifa

BETA FUSION

Scene / BLANCO			
140x140	150x150	Ø150	FREE DESIGN
			
BBEC 0028	BBEC 0029	BBEC 0030	BBEC 0031

BETA FUSION SIN HIDROMASAJE (con rebosadero integrado)

Incluido desagüe click-clack cromo

OPCIONES DE EQUIPAMIENTO

Los pedidos sin especificación de versión se suministrarán en versión A

 Cromotherapy

 Air System

Preparación para grifería

Cabezal C12 grafito o blanco



| el baño
| BAÑERAS DE ENCASTRE

ALFA FUSION



ALFA FUSION

el baño
BAÑERAS DE ENCASTRE



ALFA FUSION 200x90 blanco

alfa fusion (170-200)x(75-90)

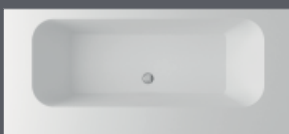

alfa fusion 190x90



alfa fusion free design

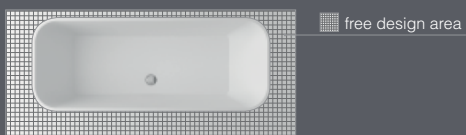

free design examples



ALFA FUSION

el baño
BAÑERAS DE ENCASTRE





ALFA FUSION 170x170 blanco

ALFA FUSION

el baño
BAÑERAS DE ENCASTRE



ALFA FUSION 178x178 blanco

alfa fusion (160-178)x(160-178)



alfa fusion 170x170



alfa fusion free design

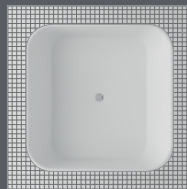

 free design area

free design examples



ALFA FUSION

el baño
BAÑERAS DE ENCASTRE
información técnica

BAÑERA ALFA FUSION / ALFA FUSION BATHTUB / BAIGNOIRE ALFA FUSION / BANHEIRA ALFA FUSION

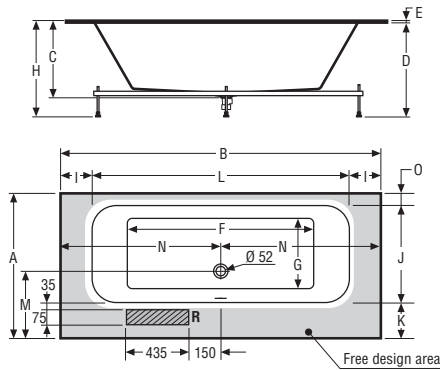
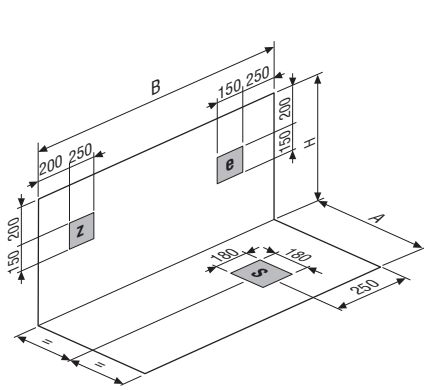

	(170-200)x(75-90)	190x90	Free design
A	750 → 900	900	750 → 900
B	1700 → 2000	1900	1700 → 2000
C	460	460	460
D	588	588	588
E	12	12	12
F	1160	1160	1160
G	430	430	430
H	600	600	600
I	50 → 200	150	50 → 200
J	600	600	600
K	105 → 225	225	105 → 225
L	1600	1600	1600
M	295 → 417	417	295 → 417
N	850 → 1000	950	850 → 1000
O	45 → 75	75	45 → 75

Medidas en mm / Sizes in mm
Mesures en mm / Medidas em mm.

Blower	0,5 Kw	230 v 50 Hz
Cromotherapy	0,05 Kw	

S Área desagüe. Desagüe Ø 40mm / Drain area. Ø40mm / Zone pour la vidange. Ø40mm / Area do escoamento.

E Área conexión eléctrica / Electrical connection area / Zone pour le raccordement électrique / Area do ligação eléctrica.

R Zona sugerida para Grifería en borde bañera, UNE 232. En los formatos con ancho inferior a 80 cm no se puede incorporar grifería. / Zone suggested for faucetry fittings on the bathtub, UNE 232. Faucetry can not be fitted to formats with a width of less than 80cm. / Zone suggérée pour Robinetterie sur le bord de la baignoire, UNE 232. Sur les formats avec ampleur inférieur à 80cm il ne peut pas s'incorporer de robinetterie. / Zona sugerido a Torneira en Banheira, UNE 232. Nos formatos com largura inferior a 80 cm não se pode incorporar torneira.

Z Conexiones para Grifería en borde bañera / Connection for the bathtub featured with faucetry / Raccordement pour Robinetterie sur le bord de la baignoire / Ligação a Torneira en Banheira.

Modelo / Model / Modèle / Modelo	200x90
Capacidad / Capacity / Capacité / Capacidade (L)	230
Volumen de expedición sin palet / Shipping volume without pallet / Volume à l'expédition sans palet / Volume expedição sin palet (m³)	1,67
Peso de expedición / Shipping weight / Poids à l'expédition / Peso de expedição (Kg)	180

UBICACIÓN DE COMPONENTES / EMLACEMENT DES COMPOSANTS / COMPONENT LOCATION / SITUAÇÃO DE COMPONENTES

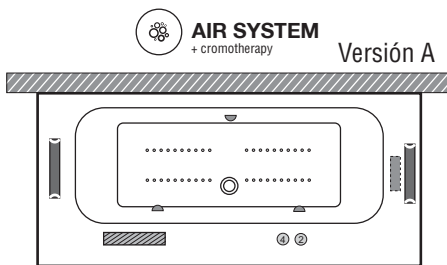

* Paneles sistema / System panel / Comande systeme / Panel Sistema.	
CROMIOTHERAPY	<ul style="list-style-type: none"> ④ Botón marcha-para Cromotherapy / On-Off Cromotherapy Buton / Bouton marche-arret Cromotherapy / Botón marcha-para Cromotherapy. ☛ Foco / Spotlight / Spot lumineux / Foco.
AIR SYSTEM	<ul style="list-style-type: none"> ② Botón marcha-para Blower / On-Off Blower Buton / Bouton marche-arret blower / Botón marcha-para Blower. ○ Inyector aire / Air injector / Injecteur air / Injetor ar. Blower / Blower / Blower / Blower.
* Grifería / Faucetry / Robinetterie / Torneira.	
Zona sugerida para Grifería / Zone suggested for faucetry fittings / Zone suggérée pour Robinetterie / Zona sugerido a Torneira en Banheira.	
* Accesorios / Accessories / Accessoires / Accesorios.	
Cabezal / Headrest / Appui-têtes / Almofada.	

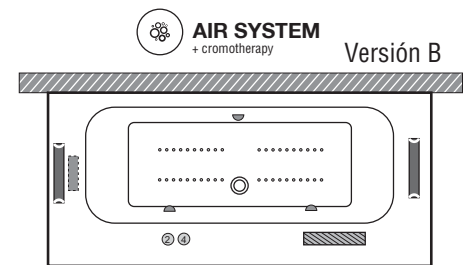

* Opcional / Optional / Optionnel / Opcional.



OPCIONES DEL PRODUCTO E INFORMACIÓN TÉCNICA IMPORTANTE

el baño
BAÑERAS DE ENCASTRE
tarifa

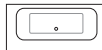
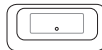
ALFA FUSION

Scene / BLANCO		
(170-200)x(75-90)	190x90	FREE DESIGN
		
		según diseño cliente
ALFA FUSION SIN HIDROMASAJE (con rebosadero integrado)	BALC 0007	BALC 0008
		BALC 0009

Incluido desagüe click-clack cromo

OPCIONES DE EQUIPAMIENTO

Los pedidos sin especificación de versión se suministrarán en versión A

 Cromotherapy

 Air System

Preparación para grifería

 Cabezal C1 grafito o blanco 

Cabezal C11 grafito o blanco 

ALFA FUSION

el baño
BAÑERAS DE ENCASTRE
información técnica

BAÑERA ALFA FUSION / ALFA FUSION BATHTUB / BAIGNOIRE ALFA FUSION / BANHEIRA ALFA FUSION

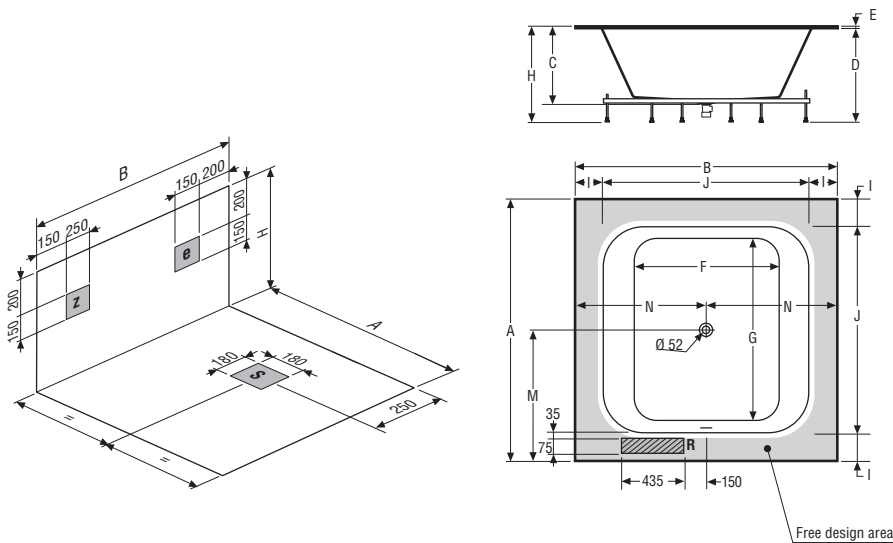

	(160-178)x(160-178)	170x170	Free design
A	1600 → 1780	1700	1600 → 1780
B	1600 → 1780	1700	1600 → 1780
C	510	510	510
D	638	638	638
E	14	14	14
F	970	970	970
G	1225	1225	1225
H	650	650	650
I	110 → 200	160	110 → 200
J	1380	1380	1380
M	800 → 890	850	800 → 890
N	800 → 890	850	800 → 890

Medidas en mm / Sizes in mm
Mesures en mm / Medidas em mm.

Blower	0,5 Kw	230 v 50 Hz
Cromotherapy	0,05 Kw	

S Área desagüe. Desagüe Ø 40mm / Drain area. Ø40mm / Zone pour la vidange. Ø40mm / Área do escoamento.

e Área conexión eléctrica / Electrical connection area / Zone pour le raccordement électrique / Área do ligação eléctrica.

R Zona sugerida para Grifería en borde bañera, UNE 232. En los formatos con ancho inferior a 170 cm no se puede incorporar grifería. / Zone suggested for faucetry fittings, UNE 232. Faucetry can not be fitted to formats with a width of less than 170 cm. / Zone suggérée pour Robinetterie sur le bord de la baignoire, UNE 232. Sur les formats avec ampleur inférieur à 170cm il ne peut pas s'incorporer de robinetterie. / Zona sugerido a Torneira en Banheira, UNE 232. Nos formatos com largura inferior a 170 cm não se pode incorporar torneira.

Z Conexiones para Grifería en borde bañera / Connection for the bathtub featured with faucetry / Raccordement pour Robinetterie sur le bord de la baignoire / Ligação a Torneira en Banheira.

Modelo / Model / Modèle / Modelo	178x178
Capacidad / Capacity / Capacité / Capacidade (L)	573
Volumen de expedición sin palet / Shipping volume without pallet / Volume à l'expédition sans palet / Volume expedição sin palet (m³)	2,88
Peso de expedición / Shipping weight / Poids à l'expédition / Peso de expedição (Kg)	274

UBICACIÓN DE COMPONENTES / EMLACEMENT DES COMPOSANTS / COMPONENT LOCATION / SITUAÇÃO DE COMPONENTES

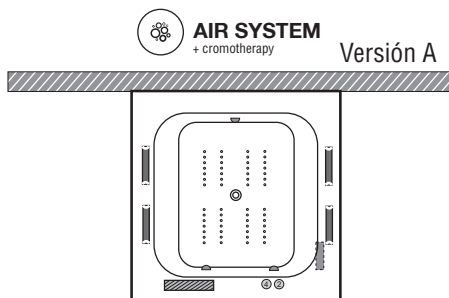

* Paneles sistema / System panel / Comande système / Painel Sistema.	
CROMOTHERAPY	<ul style="list-style-type: none"> ⊕ Botón marcha-para Cromotherapy / On-Off Cromotherapy Buton / Bouton marche-arret Cromotherapy / Botón marcha-para Cromotherapy. ☛ Foco / Spotlight / Spot lumineux / Foco.
AIR SYSTEM	<ul style="list-style-type: none"> ⊕ Botón marcha-para Blower / On-Off Blower Buton / Bouton marche-arret blower / Botón marcha-para Blower. ○ Inyector aire / Air injector / Injecteur air / Injetor ar. ▬ Blower / Blower / Blower / Blower.
* Grifería / Faucetry / Robinetterie / Torneira.	
▨ Zona sugerida para Grifería / Zone suggested for faucetry fittings / Zone suggérée pour Robinetterie / Zona sugerido a Torneira en Banheira.	
* ACCESORIOS / Accessories / Accessoires / Accesorios.	
▬ Cabezal / Headrest / Appui-têtes / Almofada.	

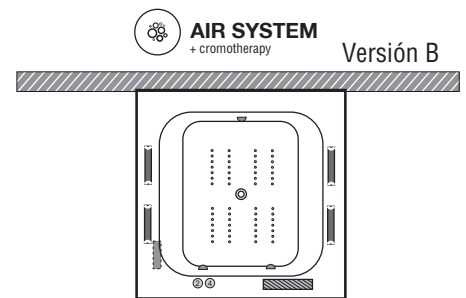

* Opcional / Optional / Optionnel / Opcional.



OPCIONES DEL PRODUCTO E INFORMACIÓN TÉCNICA IMPORTANTE

el baño
BAÑERAS DE ENCASTRE
tarifa

ALFA FUSION

Scene / BLANCO		
(160-178)x(160-178)	170x170	FREE DESIGN
		
BALC 0010	BALC 0011	BALC 0012

ALFA FUSION SIN HIDROMASAJE (con rebosadero integrado)

Incluido desagüe click-clack cromo

OPCIONES DE EQUIPAMIENTO

Los pedidos sin especificación de versión se suministrarán en versión A

 Cromotherapy

 Air System

Preparación para grifería

 Cabezal C1 grafito o blanco 

Cabezal C11 grafito o blanco 

IMAGINE

el baño
BAÑERAS ACRILICAS

PLANE 180 x 80 | 180 x 110



URBAN 170 x 80



CORA 170 x 70 | 160 x 70 | 170 x 75 | 160 x 75



JOY 180 x 90

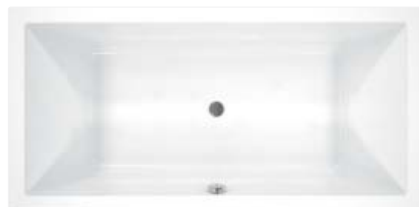

MARINA 180 x 80



INTRO 140 x 70 | 150 x 70 | 160 x 70 | 170 x 70



VELA 140 x 140



AREA 147/153 x 147/153



Acrylic / BLANCO

PLANE 180x80

PLANE 180x110

JOY 180x90

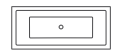
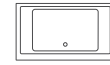
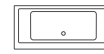

BAÑERA SIN EQUIPAMIENTO





↳ Patas para bañera (kit para montar)











↳ Estructura para faldones (montada)

BAÑERA CON EQUIPAMIENTO

Los pedidos sin especificación de versión se suministrarán en versión A
Incluido desagüe automático, acabados cromados

↳ OPCIONES DE EQUIPAMIENTO

-  Bañera + Cromotherapy
-  Bañera + Air System (Airpool)
-   Bañera + Cromotherapy + Air System (Airpool)

-    Bañera + Tec 1 (Whirlpool)
-    Bañera + Tec 2 (Whirlpool + Airpool)
-     Tec Option (Opciones para añadir a Tec 1 y Tec 2)

 Aromatherapy

 Cromotherapy

 Higienic System

 Temp Control

   Bañera + Tec Complet (Tec 2 (Whirlpool + Airpool) + todas las opciones)

↳ Preparación para grifería

↳ Cabezal C1 grafito o blanco 

Cabezal C11 grafito o blanco 

↳ Faldones para bañeras con estructura o equipamiento

Faldón frontal acrílico blanco

Faldón lateral acrílico blanco

acrylic / BLANCO		
CORA	URBAN 170x80	INTRO
170x70 • 160x70 • 170x75 • 160x75		140x70 • 150x70 • 160x70 • 170x70
		

BAÑERA SIN EQUIPAMIENTO

 Patas para bañera (kit para montar)











 Estructura para faldones (montada)

BAÑERA CON EQUIPAMIENTO

Los pedidos sin especificación de versión se suministrarán en versión A
Incluido desagüe automático, acabados cromados

OPCIONES DE EQUIPAMIENTO

-  Bañera + Cromotherapy
-  Bañera + Air System (Airpool)
-  Bañera + Cromotherapy + Air System (Airpool)

-    Bañera + Tec 1 (Whirlpool)
-    Bañera + Tec 2 (Whirlpool + Airpool)
-     Tec Option (Opciones para añadir a Tec 1 y Tec 2)

 Aromatherapy

 Cromotherapy

 Higienic System

 Temp Control

-    Bañera + Tec Complet (Tec 2 (Whirlpool + Airpool) + todas las opciones)

 Preparación para grifería

 Cabezal C1 grafito o blanco 



Cabezal C11 grafito o blanco 

Cabezal C12 grafito o blanco 

 Faldones para bañeras con estructura o equipamiento

Faldón frontal acrílico blanco

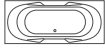
Faldón lateral acrílico blanco

Acrylic / BLANCO		
MARINA 180x80	VELA 140x140	AREA 153x153
		

BAÑERA SIN EQUIPAMIENTO

-  Patas para bañera (kit para montar)

-  Estructura para faldones (montada)



BAÑERA CON EQUIPAMIENTO



Los pedidos sin especificación de versión se suministrarán en versión A
Incluido desagüe automático, acabados cromados



OPCIONES DE EQUIPAMIENTO





-  Bañera + Cromotherapy

-  Bañera + Air System (Airpool)

-   Bañera + Cromotherapy + Air System (Airpool)

-    Bañera + Tec 1 (Whirlpool)

-    Bañera + Tec 2 (Whirlpool + Airpool)

-     Tec Option (Opciones para añadir a Tec 1 y Tec 2)

 Aromatherapy





 Cromotherapy

 Higienic System

 Temp Control

-    Bañera + Tec Complet (Tec 2 (Whirlpool + Airpool) + todas las opciones)

Preparación para grifería









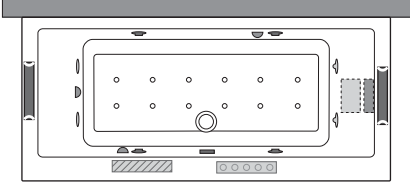
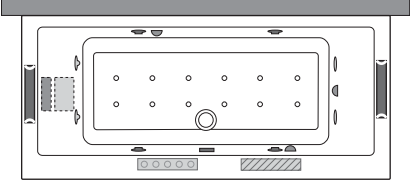
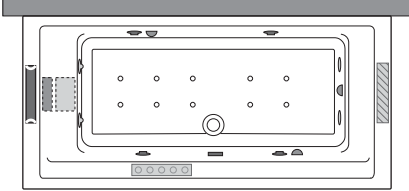
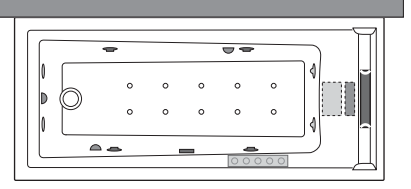
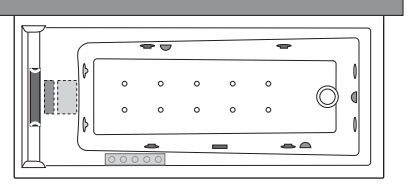
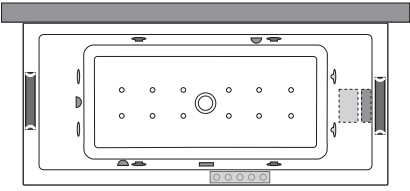
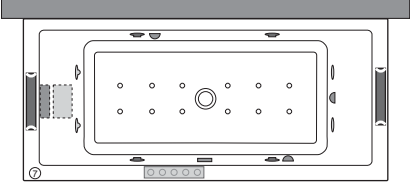
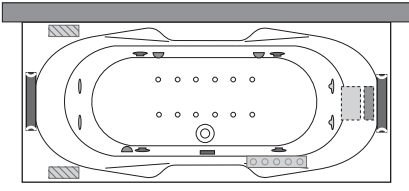
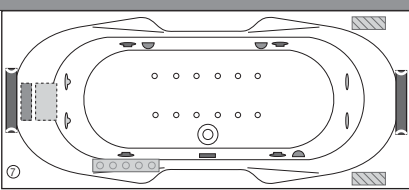
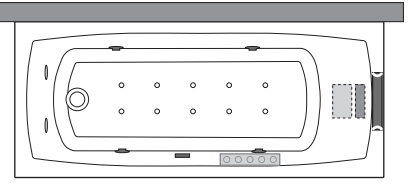
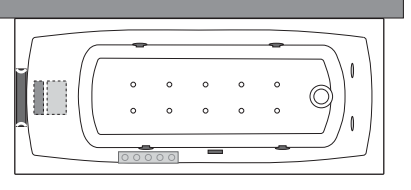

 Cabezal C1 grafito o blanco		-	-
Cabezal C2 grafito o blanco		-	-
Cabezal C5 grafito, blanco o azul		-	-
Cabezal C11 grafito o blanco		-	-
Cabezal C12 grafito o blanco		-	-

Faldones para bañeras con estructura o equipamiento







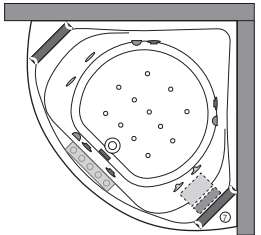
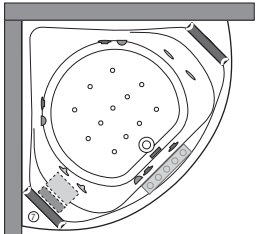
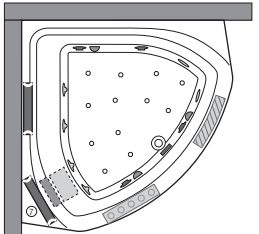





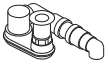
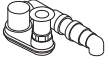





Faldón frontal acrílico blanco

Faldón lateral acrílico blanco

VERSIONES DE MONTAJE DE COMPONENTES DE HIDROMASAJE

PLANE	URBAN	CORA
<p>Versión A</p>  <p>Versión B</p> 	<p>Versión B</p> 	<p>Versión A</p>  <p>Versión B</p> 
JOY	MARINA	INTRO
<p>Versión A</p>  <p>Versión B</p> 	<p>Versión A</p>  <p>Versión B</p> 	<p>Versión A</p>  <p>Versión B</p> 
VELA	AREA	<p>Paneles sistema System panel / Comande système / Painel Sistema.</p>  Mandos hidromasaje / Hydromassage controls / Commandes hydromassage / Comandos hidromassagem. <p>Grifería Faucetry / Robinetterie / Torneira.</p>  Zona sugerida para Grifería / Zone suggested for tap fittings / Zone suggérée pour Robinetterie / Zona sugerido a Torneira en Banheira. <p>Accesorios Accessories / Accessoires / Accesorios.</p>  Cabezal / Headrest / Appui-tête / Almofada. <p>Componentes sistema System component / Elements système / Componentes Sistema.</p> <ul style="list-style-type: none">  Jet plano / Plain Jet / Jet plan / Jet avião.  Inyector aire / Air injector / Injecteur air / Injetor ar.*  Boca aspiración / Suction element / Bouche d'aspiration / Boca aspiración.  Electrobomba / Electric pump / Electropompe / Electrobomba.  Blower / Blower / Blower.*  Foco / Spotlight / Spot lumineux / Foco.*
<p>Versión A</p>  <p>Versión B</p> 	<p>Versión B</p> 	

tarifa

VÁLVULAS PARA SERIES						
SPACE BETA ALFA	VSPS 0036	Válvula click-clack cromo				
ALFA ESSENTIAL DECO	VSPS 0037	Válvula click-clack con rebosadero + sifón cromo				
BETA ESSENTIAL ALFA ESSENTIAL 142x142	VSPS 0038	Válvula presurizada H1 cromo				
SPACE ALFA ESSENTIAL 164x65	VSPS 0039	Válvula presurizada H2 cromo				
PLANE / CORA / URBAN INTRO / MARINA / VELA AREA	VSPS 0040	Válvula automática cromo				
JOY	VSPS 0041	Válvula automática cromo				
PLANE / CORA / URBAN INTRO / MARINA / VELA AREA	VSPS 0042	Válvula automática con llenado por rebosadero cromo				
JOY	VSPS 0043	Válvula automática con llenado por rebosadero cromo				
CABEZALES PARA SERIES						
ALFA FUSION PLANE / JOY / CORA URBAN / INTRO / AREA	HSPS 0001	Cabezal C1 blanco		HSPS 0002	Cabezal C1 grafito	
ALFA ESSENTIAL ALFA ESSENTIAL DECO ALFA FUSION / PLANE JOY / CORA / URBAN / VELA	HSPS 0003	Cabezal C11 blanco		HSPS 0004	Cabezal C11 grafito	
SPACE BETA ESSENTIAL BETA FUSION INTRO / AREA	HSPS 0005	Cabezal C12 blanco		HSPS 0006	Cabezal C12 grafito	
VELA	HSPS 0007	Cabezal C2 blanco		HSPS 0008	Cabezal C2 grafito	
MARINA	HSPS 0009	Cabezal C5 blanco		HSPS 0010	Cabezal C5 grafito	
	HSPS 0011	Cabezal C5 azul				



Scene

Es una composición avanzada de materias minerales, polímeros orgánicos y aditivos específicos cuya finalidad es la consecución de formas complejas por molde. Lo podemos situar entre los materiales denominados "solid surface", es decir un material sintético homogéneo que no tiene piel, por lo que la superficie expuesta tiene las mismas propiedades que el interior. Está formulado y producido para la consecución de productos finales destinados a la arquitectura. Especialmente interesante es su aplicación en el ámbito del baño debido a sus excelentes características físicas, mecánicas, químicas e higiénicas. Estas propiedades, junto con la belleza resultante de las piezas por su aspecto y diseño, lo hacen resaltar en su comparación con otros materiales.

Gran rigidez

Agradable al tacto

Antideslizante

Antibacteriano

*Resistente a la
humedad*

*Resistente a
agentes químicos*

Color y textura

TEXTURA LISA



BLANCO

CONDICIONES GENERALES DE VENTA

ÁMBITOS DE APLICACIÓN

Estas Condiciones Generales de Venta son aplicables a todas las ventas y/o servicios descritos, mencionados, promocionados o incluidos en cualquiera de sus formas, en nuestros catálogos, promociones, listas de precios, y presupuestos. Absara Industrial S.L. se reserva el derecho a modificar los presentes términos y condiciones de venta.

PEDIDOS

La realización de un pedido supone la aceptación incondicional de las presentes Condiciones Generales de Venta. La notificación de pedidos por parte del cliente, se realizará por escrito, vía correo electrónico (comercial@absaraindustrial.com) o fax (964 691 922), y sólo serán vinculantes una vez aceptados por Absara Industrial S.L. mediante la emisión de una confirmación de pedido por medio de correo electrónico. El cliente de Absara Industrial S.L. deberá revisar la confirmación de pedido y, en su caso, notificar por escrito y de inmediato cualquier discrepancia. Los presupuestos y/u ofertas económicas realizadas por Absara Industrial S.L. sólo serán válidos por escrito y durante el plazo que en ellos se indique. De no indicarse ningún plazo éste será de 30 días naturales. La venta de cualquier producto incluido en esta tarifa se efectuará siempre en firme y condicionada a la obtención de coberturas de riesgo por parte de la compañía aseguradora de crédito de Absara Industrial S.L., consecuentemente en ningún caso se entenderá que el cliente de Absara Industrial S.L. recibe la mercancía en concepto de depósito o cualquier tipo de institución distinta de la mera compraventa mercantil.

ENTREGA / ACEPTACIÓN / DEVOLUCIÓN

Los plazos de entrega se considerarán siempre orientativos, no aceptando ningún tipo de responsabilidad en el caso de demoras que no excedan de 15 días de la fecha originariamente convenida y en ningún caso en aquellas originadas por causas de fuerza mayor. El comprador de Absara Industrial S.L. asume la obligación de examen inmediato de la mercancía recibida y en el caso de presentar ésta cualquier incidencia relativa a cantidad o calidad de las mismas, ésta deberá ser tramitada durante las veinticuatro horas posteriores a su entrega. Una vez transcurrido este plazo, el producto se considerará aceptado por parte del cliente y no cabrá reclamación alguna por este concepto. Absara Industrial S.L. no admitirá ningún tipo de devolución sin su previa autorización por escrito que será expresa y para cada caso concreto y siempre contemplará el resarcimiento de los gastos causados así como una reducción del importe del precio de la mercancía.

PRECIOS Y TÉRMINOS DE PAGO

Los precios de esta tarifa son precios venta público orientativos y no incluyen I.V.A. ni otros impuestos o cualquier recargo a que pudiera ser sometida la venta por organismos oficiales. Absara Industrial, S.L. retendrá el dominio de la mercancía servida, incluso en el supuesto de que hubiera sido transmitida a terceros hasta que sus importes le hayan sido totalmente liquidados. Cualquier demora en el cumplimiento de las obligaciones de pago del precio de las mercancías o servicios suministrados provocará la retención inmediata de todos los pedidos en curso.

GARANTÍA

Las Garantías se rigen por la legislación vigente al respecto y por las garantías comerciales que extendiendo las legales se incluyen en la póliza de garantía que se entrega junto al producto.

INSTALACIÓN Y MONTAJE DE PRODUCTOS

Los productos exigen que su instalación y montaje sea realizado por personal cualificado y siguiendo siempre las instrucciones del producto y que se acompañen en cada uno de los artículos. El personal que proceda a la instalación del producto, especialmente en platos de ducha, deberá verificar el producto previamente a su instalación, llevar a cabo la instalación de manera correcta, verificándolo a su fin antes de terminar la obra con alicatados, instalación de mamparas, etc. Absara Industrial S.L. o en su caso la empresa vendedora no se hará cargo de los costes que puedan ocasionarse derivados de no respetar este proceso, tales como desmontaje de mampara, reposición de azulejos o pavimentos, etc.

PROTECCIÓN DE DATOS

El cliente que suscribe el contrato reconoce frente a Absara Industrial S.L., de conformidad con lo regulado en la Ley Orgánica 15/1999 de 13 de diciembre sobre tratamiento automatizado de los datos de carácter personal, que presta su consentimiento expreso para que los datos indicados puedan ser tratados automatizadamente con el fin de entablar la relación comercial oportuna. Asimismo, podrá hacerse uso de esta información para ofrecer al cliente productos o servicios de la empresa.

Conforme a la Ley de Protección de Datos, el cliente de Absara Industrial S.L. podrá ejercer en cualquier momento el derecho a acceder, rectificar y cancelar sus datos y oponerse a su tratamiento, dirigiéndose por correo electrónico a Absara Industrial S.L. en su dirección comercial@absaraindustrial.com.

PARTICULARIDADES DE VENTA

Los precios de venta al público incluidos en la presente tarifa podrán verse modificados en las condiciones particulares que con carácter general o puntual establezca Absara Industrial, S.L. con cada uno de sus clientes, en el bien entendido que tal modificación deberá constar por escrito con la aceptación de ambas partes. Esta tarifa anula todas las anteriores y es propiedad de Absara Industrial, S.L. al igual que toda la documentación suministrada, reservándose el derecho a introducir cualquier modificación en la misma y no haciéndose responsable de cualquier error contenido en ella.

hidrobox[®]

by absara

ES

 +34 964 105 176

 comercial@absaraindustrial.com

EN

 +34 964 657 272

 export@absaraindustrial.com

FR

  N°Azur 0 811 66 57 41

PRIX APPEL LOCAL

 france@absaraindustrial.com

DE

 Rufen Sie uns an unter unsere Kunden Hotline:
+49 01 807 808 777

Erste 30 Sekunden kostenlos; Vom Festnetz 0.14 cent/Minute; Vom Mobilnetz 0.42 cent/Minute

 deutschland@absaraindustrial.com

ABSARA INDUSTRIAL S.L.
Partida Saloni, s/n • 12130 San Juan de Moró • Castellón SPAIN
Tel. +34 964 657 272 • Fax +34 964 691 922
absara@absaraindustrial.com • www.hidrobox.com